

# 12X/23X H.265+ Mini PTZ Dome Network Camera



IP66

IK10

DATASHEET

## KEY FEATURES

- ▶ Smart Stream (Bandwidth, storage and bit rate are saved with Smart Stream On, eg, H.265+ saves 70%~80% bandwidth that of H.264.)
- ▶ 0.002Lux Starlight (Delivering detailed color image even in the low light environments reaching 0.002Lux (Color) or 0Lux (B/W).)
- ▶ 140dB Super WDR (Excellent performance even when the ratio of the luminosity of brightest and darkest is up to 140dB.)
- ▶ Advanced Functions (Boasting to support various advanced functions such as HLC, Defog, ROI.)
- ▶ Smart PTZ Motion Detection (Pan and tilt to the position of motion detected area automatically and zoom in synchronously.)
- ▶ 255 Preset Positions (The user can easily control the lens position via mouse to monitor interested area and set up to 255 preset positions for patrolling.)
- ▶ Video Content Analysis (With 10 detection modes, VCA greatly enhances the performance bringing comprehensive surveillance functions.)
- ▶ Keyboard Control (Shortcut keys for PTZ control via Milesight Keyboard.)

## 12X/23X Optical Zoom

The 12X/23X optical zoom can zoom up to distant subjects while still maintaining the clarity, delivering high quality video over the entire zoom range.

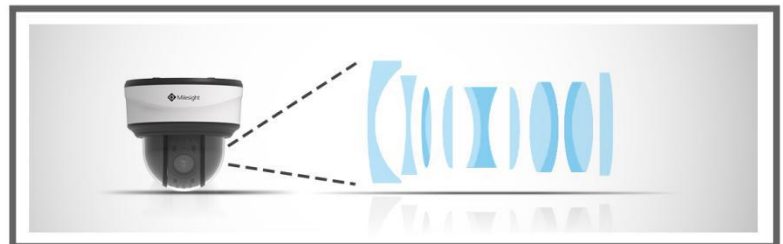

## Smart IR II Technology

It allows the camera to catch better images regardless of object distance with High Beams and Low Beams whose brightness could be adjusted manually or automatically. Also, the innovative IR Anti-reflection Panel protects the lens from IR interference.

## High Speed & Precise Movement

With a sophisticated pan/tilt mechanism, the 12X/23X H.265 Mini PoE PTZ Dome Network Camera provides fast, precise movement with 360° endless pan and -5~90° (Auto Flip). Maximum pan speed of 240°/s and tilt speed of 200°/s make the camera a mighty Speed Dome model.

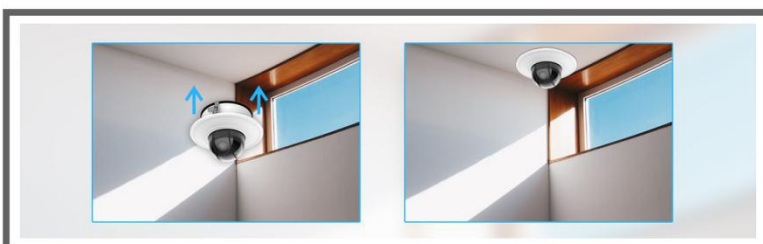

## Recessed Installation

With recessed installation, the 12X/23X H.265 Mini PoE PTZ Dome Network Camera is easily blend in with the environment to provide discreet surveillance.

# 12X/23X H.265+ Mini PTZ Dome Network Camera



	Model	MS-C2971-X12RPB (2MP)	MS-C2971-X23RPB (2MP)	MS-C5371-X12HPB (5MP)	MS-C5371-X23HPB (5MP)
Camera	Image Sensor	1/2.8" Progressive Scan CMOS			
	Min. Illumination	Color: 0.002Lux@F1.2 B/W: 0Lux with IR on		Color: 0.005Lux@F1.2 B/W: 0Lux with IR on	
	WDR	140dB Super WDR		120dB Super WDR	
	Shutter Time	1/100000s~1s			
	Digital Zoom	16X			
	Day&Night	ICR Filter Auto Switch			
	S/N	>55dB			
Lens	Focal Length	5.3~64mm, 12X Optical Zoom	5~117mm, 23X Optical Zoom	5.3~64mm, 12X Optical Zoom	5~117mm, 23X Optical Zoom
	Zoom Speed	Approx 4s (Wide-Tele)	Approx 6s (Wide-Tele)	Approx 4s (Wide-Tele)	Approx 6s (Wide-Tele)
	Field of View	H61°~H5°/D69°~D5°/ V36°~V2°	H60°~H3°/D69°~D4°/ V35°~V2°	H57°~H4°/D69°~D5°/ V44°~V1°	H55°~H3°/D68°~D4°/ V42°~V2°
	Focus Control	Auto/Semi-Auto/Manual			
	Minimum Working Distance	1000~1500mm (Wide-Tele)(5.3~64mm) / 100~1500mm (Wide-Tele)(5~117mm)			
	Aperture	F1.6~F2.8	F1.5~F3.5	F1.6~F2.8	F1.5~F3.5
	Iris Control	Auto			
PTZ	Pan Range / Pan Speed	360° endless; Pan Manual Speed: 0.5~180°/s, Pan Preset Speed: 240°/s			
	Tilt Range / Tilt Speed	-5°~90° (Auto Flip); Tilt Manual Speed: 0.5~120°/s, Tilt Preset Speed: 200°/s			
	Proportional Zoom	Support			
	Preset Quantity	255			
	Preset Freezing	Support			
	Patrol	8 Patrols, up to 48 presets each patrol			
	Pattern	4 Patterns			
	Power Off Memory	Support			
	PTZ Position Display	ON/OFF			
3D positioning	Support				
IR	IR Distance	Up to 120m			
	IR Angle	Auto/Manual			
Video	Max. Image Resolution	1920x1080		2592x1944	
	Primary Stream	60fps@(1920x1080, 1280x960, 1280x720, 704x576)		30fps@(2592x1944), 45fps@(2048x1536), 60fps@(1920x1080, 1280x960, 1280x720, 704x576)	
	Secondary Stream	60fps@(704x576, 640x480, 640x360, 352x288, 320x240, 320x192, 320x180)			
	Tertiary Stream	30fps@(1920x1080, 1280x720, 704x576, 640x480, 640x360, 320x240, 320x192, 320x180)			
	Video Compression	H.265+/H.265(HEVC)/H.264+/H.264/MJPEG			
	Video Bit Rate	16Kbps~16Mbps(CBR/VBR Adjustable)			
	Image Setting	Brightness/Contrast/Saturation/Sharpness			
Network	Ethernet	1*RJ45 10M/100M Ethernet Port			
	Network Storage	NAS(Support NFS, SMB/CIFS)			
	Protocol	IPv4/IPv6, ARP, TCP, UDP, RTP, RTSP, RTCP, HTTP, HTTPS, DNS, DDNS, DHCP, FTP, NTP, SMTP, SNMP, UPnP, Bonjour, SIP, PPPoE, VLAN, 802.1x, QoS, IGMP, ICMP, SSL			
Audio	Audio Compression	G.711/AAC/G.722/G.726			
	Audio I/O	1/1			
System	Alarm I/O	1/1			
	Storage	Support microSD/SDHC/SDXC Card Local Storage, up to 256G			
	Advanced Function	Auto Tracking, Privacy Masking, BLC, HLC, 2D DNR, 3D DNR, ROI, Defog, AWB, EIS, IP Address Filtering, AGC, Anti-flicker, Corridor Mode, Deblur			
	SIP/VoIP Support	Yes, Voice & Video-over-IP			
	Event Trigger	Motion Detection, Network Disconnection, External Input, Audio Alarm, etc.			
	Event Action	FTP Upload, SMTP Upload, SD Card Record, External Output, SIP Phone, PTZ Motion, HTTP Notification, etc.			
	Video Analysis (Optional)	Region Entrance, Region Exiting, Advanced Motion Detection, Tamper Detection, Line Crossing, Loitering, Human Detection, People Counting, Object Left, Object Removed			
System Compatibility	ONVIF Profile S & G & T				
General	Working Condition	Temperature: -40°C~60°C / Humidity: 0~90%(Non-condensing)			
	Power Supply	PoE (802.3at) / DC 12V/3A ± 10%			
	Power Consumption	10W MAX/17W MAX (With IR on)			
	Weather Proof/Housing	Up to IP66-rated for Weather-resistant Performance / Vandal-proof IK10-rated Metal Housing			
	Surge Protection	4KV			
	Dimensions/Weight	Φ183mmX174.8mm/2Kg			
Warranty	2 Years / 3 Years (Optional)				

# 12X/23X H.265+ Mini PTZ Dome Network Camera



## Structure Diagrams

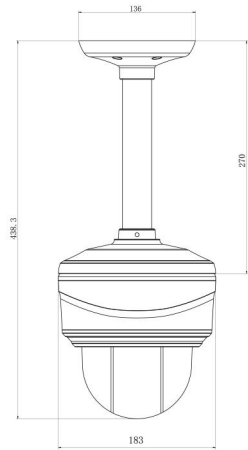
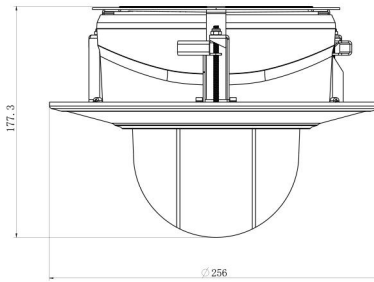
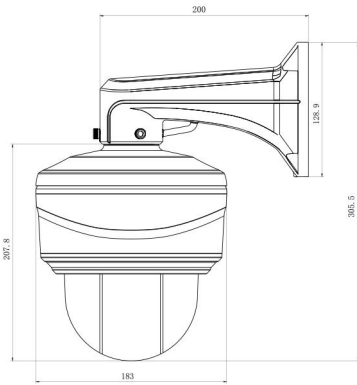
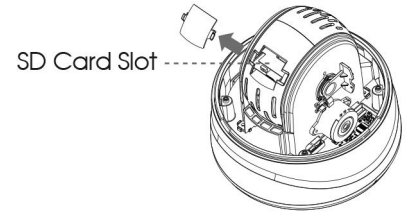
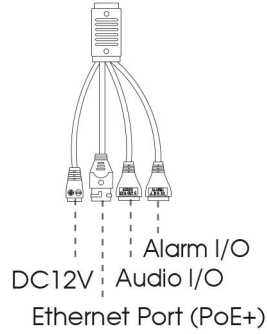
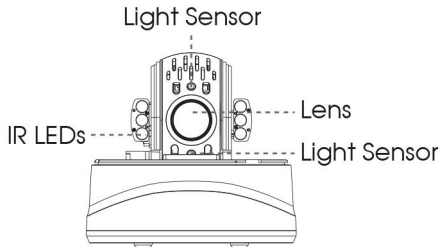

Units: mm

## Accessories Support

A42-L Extension Lever  
Weight: 325g  
Dimension: 57\*250mm



A43 Junction Box  
Weight: 1000g  
Dimensions: 195\*164\*80mm



A77 Wall Mount  
Weight: 650g  
Dimensions: 262\*185\*138mm



A78 Recessed Mount  
Weight: 715g  
Dimensions: 256\*256\*94mm



A79 Pendant Mount  
Weight: 850g  
Dimensions: 256\*256\*245mm



Milesight Technology Co.,Ltd. | [www.milesight.com](http://www.milesight.com)

Contact Us: [sales@milesight.com](mailto:sales@milesight.com) [support@milesight.com](mailto:support@milesight.com)

Add: 220 NE 51st Street, Oakland Park, Florida 33334, USA  
Tel: +1-800-561-0485

Add: 925, Anyang SK V1 Center, LS -ro 116beon-gil, Dongan-gu, Anyang-si, Korea  
Tel: +82-31-990-7772

Add: No.23 Wanghai Road, 2nd Software Park, Xiamen, China  
Tel: +86-592-5922772

